

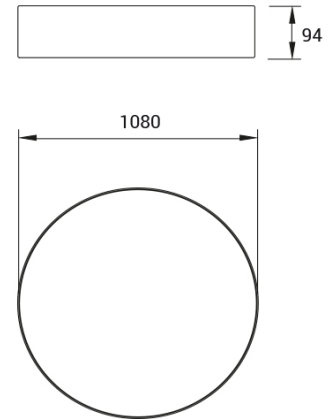

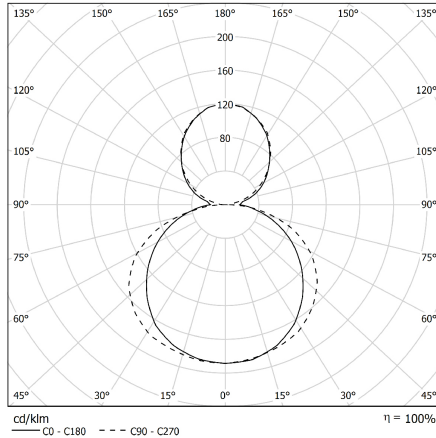

## BEN MAXI IP40 PG Double Emission

Frosted Acryl-Satiné impact resistant.

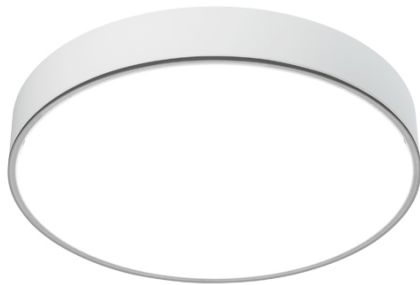

CODE		FLUX	SIZE	CERTIFICATIONS
10DI161PGK3	161W: 125W+36W 3000K	19885lm	Ø 1080mm	   

### Optics

PG diffuser with frosted Acryl-Satiné and impact resistant diffuser UGR<22. Direct/indirect emission.

### Body

Aluminum with epoxy powder coating.

### Technical features

- Built-in driver
- >125 lm/W
- CRI >125
- Eye safety: RG0/RG1
- Mac Adams 3
- L80/B20 >80.000h
- 5 years warranty

### Legal references

In compliance with the safety standards EN 60 598-1 and UNI EN 12464-1 (lighting for working places).

### Wiring

RE: Standard wiring is 230-240V/50-60Hz with power factor >0.97

